

NEW JCB TELEHANDLER

**BHARAT
KA JCB**



Powered by

JCB ENGINE
eCOMAX



CEV IV
STAGE

THE VERSATILITY THAT SUCCESS DEMANDS.

530-70, 540-70, 530-110

Gross power: 55kW(74hp) | Lift capacity: 3000-4000kg | Lift height: 7m to 11m

JCB

Always looking for a better way

The story of JCB is one of innovation, ambition and sheer hard work. From small beginnings building agricultural tipping trailers in 1945, to the global force in manufacturing the company has become today, JCB has constantly pushed the boundaries in our desire to be the best. My father and company founder Joseph Cyril Bamford's motto was, "Jamais content", and that is exactly right – we are never content with our achievements. But I believe that even he would be amazed by what the company has become. Today, we have 22 plants on four continents and more than 750 dealers around the world.

JCB is one of the true, great British success stories.

LORD BAMFORD



India's Material Handling Expert

Introducing the all-new JCB Telehandler with side-mounted engine to meet your specific, exact and absolute needs. With a wide range of attachments customised for specific applications in various industries, the JCB Telehandler comes with an all-new global side-mounted engine design to enhance reliability, visibility, safety and comfort while delivering better productivity at your worksite. Look for a better way with JCB Telehandler.

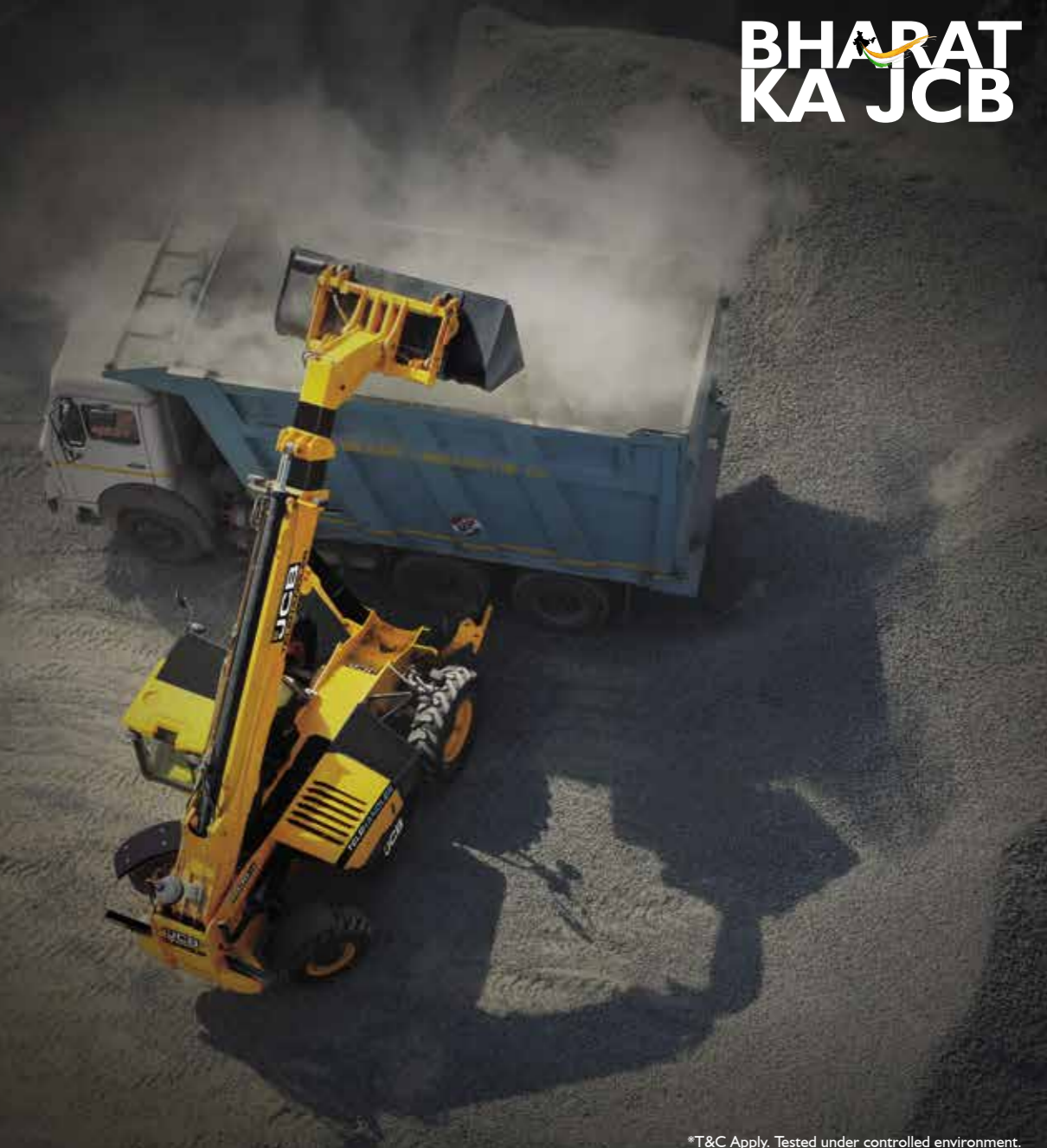

**BHARAT
KA JCB**

*T&C Apply. Tested under controlled environment.

JOURNEY OF JCB TELEHANDLER

The astonishing journey of our telehandler has inspired millions of business success stories over the years across industries. The voyage has been full of challenges leading to the evolution of the modern-day telehandler. Here is a glimpse of the fascinating time travel covered by one of our most preferred machine around the world.



JCB 520 Telehandler launched, a two-wheel drive machine with a 6.4m lift height and 2.25 tonnes maximum lift capacity



Adopted the "Loadall" name for our telescopic handler range.



Introduced our own slick-shifting synchro-shuttle transmission, a first-of-its kind innovation.



Introduced a side-mounted engine with greater visibility, allowing for a lower boom mounting position.



Loadall reached a significant production milestone by becoming the first Telehandler brand to hit the 100,000 mark.



We continued to revolutionise businesses across the globe becoming the world's no. 1 Telehandler manufacturer.



Started manufacturing Telehandlers in India and launched the 530-70 and 530-110 models



Set up our manufacturing facility in Jaipur, further strengthened our position as a market leader.



Strived to become the most versatile solutions provider with 300 machines, across 30 industries.



Over 1000 Telehandlers made in India working across India and South Asian region.



The all-new side-mounted engine Telehandler launched with Hi-Viz design.

WHY YOU NEED THE ALL NEW JCB TELEHANDLER?

THE PERFECT INVESTMENT

THE ALL-NEW JCB TELEHANDLER IS A HIGHLY VERSATILE MACHINE WITH ADDED DURABILITY, LIFT CAPACITIES UP TO 4000 KG, LIFT HEIGHT UP TO 11M AND A WIDE RANGE OF ATTACHMENTS. THE JCB TELEHANDLER IS TRULY A MULTI-TASKER THAT'S MANY MACHINES IN ONE AND IS CAPABLE TO DO JOBS THAT OTHER SPECIALISED MACHINES SUCH AS CRANES, LOADING SHOVELS, FORKLIFT TRUCKS, SWEEPERS AND AERIAL WORK PLATFORMS ARE ABLE TO DO.

ONE OF WORLD'S FAVOURITE, JCB TELEHANDLER ENCAPSULATES:



GREATER VERSATILITY

Wide range of attachments available for use in multiple industries gives you greater convenience and options at work.



BETTER PRODUCTIVITY

Greater lift capabilities and higher reach of the Telehandler gives you more productivity at your site.



ECONOMICAL AND COST EFFECTIVE SOLUTION

Eliminates multiple handling and machine usage which makes the cost of operations economical.



MECHANISATION OF JOBS

Lower cost due to mechanisation of manual jobs, resulting in quick, safe and easy processes.



SUPERIOR SAFETY

Enhanced site safety with ROPS and FOPS cabin design. Global design ensures improved visibility and site safety.



JCB TELEHANDLERS ACCOMPLISHING THE NEED OF CUSTOMERS ACROSS DIFFERENT INDIAN INDUSTRIES



FACETS THAT MAKE MACHINE VERSATILE



Multiple Attachments

Replace the work of many machines with a wide range of attachments.



Ease of Maintenance

The new side engine allows quicker daily maintenance. Better versatility and productivity - With a wide range of attachments this machine can replace multiple machines.



HiViz Global Side Engine Design

Global standard side engine design with excellent all-round visibility and manoeuvrability.

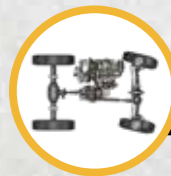

Maximum Manoeuvrability

The rear-wheel steer gives high manoeuvrability to the machine.



JCB Quick Hitch

Allows safe, rapid attachment change without leaving the cab, minimising downtime.



JCB LiveLink

JCB's advanced telematics technology helps to monitor the machine at all times.



Cabin Comfort

The operator gets greater visibility, lower noise, and more efficient air conditioning.



Greater Reliability

A narrower chassis and new boom design can help in increasing overall productivity of the machine.



MADE IN INDIA, MADE FOR SUCCESS.

Introducing the **NEW**
CEV Stage IV ecoMax Engine.

Efficient | Reliable | Simple



Well tested 
1,00,000+
cumulative hours



CRDi

16
Valves
Effort

VARIABLE
GEOMETRY
TURBO
CHARGER

ROBUST FUEL
FILTRATION
SYSTEM

WATERPROOF
IP69
CONNECTORS

POWERFUL JCB ECOMAX ENGINE

- 1 JCB ecoMAX 444 is the one of the efficient & reliable engines in construction industry. The combination of CRDI technology with high pressure fuel line & swirl design in combustion chamber reduces the complicity & manages to achieve the CEV Stage IV norms value efficiently without after treatment.
- 2 A fuel-efficient engine with CRDI Technology- low SFC, 16 valves effort and improved swirl for cleaner combustion.
- 3 Higher performance due to high torque at low speed. EGR with 2 stage cooling mechanism and turbocharger with Waste Gate Technology (WGT).
- 4 High swirl design for better combustion, no after treatment required.
- 5 Sturdy design of bedplate, robust fuel filtration system and IP69 connectors make the engine durable and reliable.
- 6 The engine is designed and tested rigorously in a controlled environment to adapt to Indian conditions for more than 1,00,000 cumulative hours.
- 7 Common Rail Direct Injection (CRDI) technology saves fuel, gives more power and cleaner emission norms.
- 8 High performance and more power with turbocharger.
- 9 Advanced sensors to continuously monitor engine health.



STRENGTH & DURABILITY THAT SUCCESS DEMANDS

IN ORDER TO BE TRULY EFFICIENT, OUR JCB TELEHANDLERS ARE DESIGNED TO PROVIDE YOU WITH MAXIMUM UPTIME. TO DO THAT, WE BUILD OUR MACHINES TO BE AS RUGGED AS POSSIBLE, USING HIGH-QUALITY COMPONENTS AND INNOVATIVE MANUFACTURING PROCESSES. THIS, IN TURN, DELIVERS MAXIMUM SERVICE LIFE.

Tough boom design

- 1 U-shaped boom and single closing plate incorporating cat tail weld to reduce joints and stress points.
- 2 A minimum of 1m boom overlap leading to structural rigidity of the boom.
- 3 Hydraulic extension rams and ground engaging design better suited for heavy-duty bucket applications.
- 4 20 mm thick one piece narrow chassis side plates with improved torsional rigidity.
- 5 Developed new narrow chassis for higher structure life.

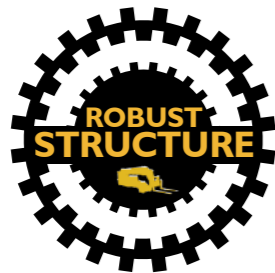

The boom on a JCB TELEHANDLER is mounted low in the chassis, providing an extremely rigid structure and maximum over-the-shoulder visibility.

Centralised lift and displacement rams ensure load stress is evenly distributed.

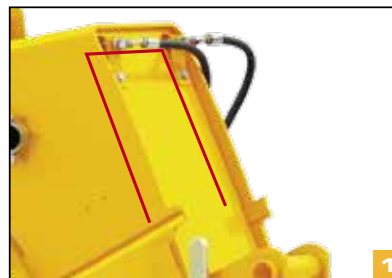

Durable components:

- 6 At JCB, we make our own axles, transmissions and engines - all designed to work in perfect harmony for optimum reliability.
- 7 The lift, tilt and extension rams are held in place by keyhole castings for even greater structural integrity.
- 8 Proven components- to prove how good our ecoMAX engines are, we've tested them in 70 different machines across the toughest applications and environments.*

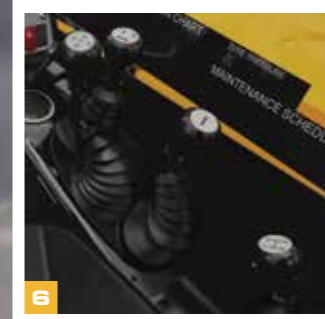

PROVEN & RELIABLE JCB DRIVELINE

POWERFUL ENGINE
The proven fuel-efficient engine with CRDI technology provides more productivity and maximum efficiency.



*T&C Apply. Tested under controlled environment.

COMFORT & USABILITY CUSTOMISED FOR SUCCESS

JCB TELEHANDLER OFFERS TOTAL COMFORT WITH SPACIOUS CABINS, REDUCED NOISE LEVELS, BETTER AIRFLOW, VENTILATION WITH AIR CONDITIONING AND SUSPENSION SEAT FOR THE OPTIMUM DRIVING POSTURE. THE WHOLE POINT OF ANY CAB IS TO PUT THE OPERATOR IN CONTROL AND JCB TELEHANDLER DOES THIS WITH SIMPLICITY AND STYLE.



1 Two-wheel steer suiting Indian working conditions which offers better operating cost and efficiency.

2 Air-conditioned and well ventilated spacious cabin with a split door and rear window.

3 Integral LMI (Load Moment Indicator) display the load through the range and warn the operator by visual and audio warnings in the event of the load exceeding the limit with a large easy to view inclinometer showing the machine's angle.

4 Smooth and ergonomically fitted control levers provide light, responsive control for precise load placement at reach or height.

5 Forward and reverse control are placed on the steering column for ease of access.

6 Gear shifting efforts reduced by 20% and gear linkage redesigned for reducing the effort force value to 4.2kg from 5.2kg, compared to previous model.

7 Angle roof bars for optimal visibility at height.

8 Comfortable operator seat, tinted & laminated glass, sunblind enhance cabin comfort.

9 Speedometre is changed from analogue to digital which is now more accurate.

Productive controls

10 An optional reversing fan can be used to clear dust and debris from the cooling system to maintain performance.

11 Global standard side engine design with low boom mounting ensuring high all-around visibility.



All-around better visibility and manoeuvrability

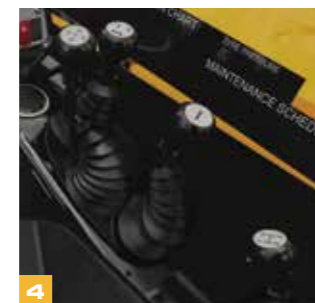
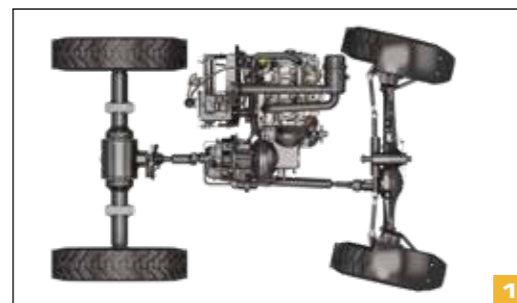

New Informative Digital Cluster Display

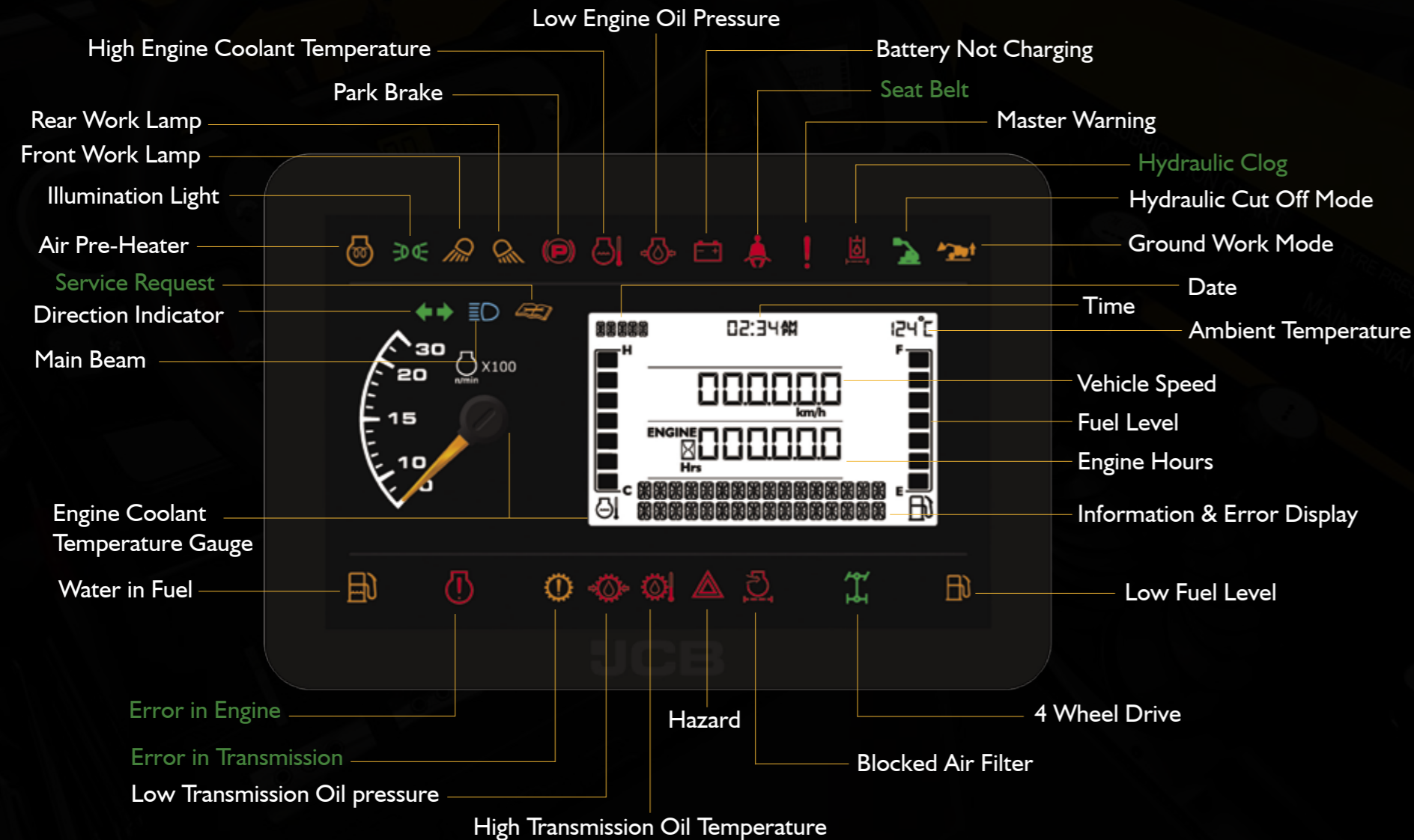

SUCCESS THAT IS SAFE & SECURE

WE EQUIP OUR TELEHANDLERS WITH STRINGENT SAFETY MEASURES TO PROTECT FROM ACCIDENTS, AS WELL AS EFFECTIVE SECURITY TECHNOLOGY TO GUARD AGAINST THEFT.

- 1 ROPS & FOPS cabin structure for operator safety.
- 2 Stabiliser cut-off for safe working operation.
- 3 Optional hydraulic cut-off feature for operator safety to ensure machine operations within safe load capacity.
- 4 For quick, easy and safe access, JCB Telehandler have three-point access and two cab steps.
- 5 Hose burst check valves on the rams prevent collapse if a hose fails.
- 6 JCB Telehandler has an excellent rearward and off-side visibility, courtesy low boom and bonnet profile and low boom pivot.
- 7 JCB Telehandler comes equipped with a full set of side and rearview mirrors for all-round visibility and safety compliance. For extra safety, a reverse alarm is standard-fit on all JCB Telehandlers.
- 8 For safety, lock pin to be engaged for locking control lever, in case of operator platform.
- 9 Independent braking improves machine manoeuvrability
- 10 Angle metre on the boom, informs operator for current boom position.

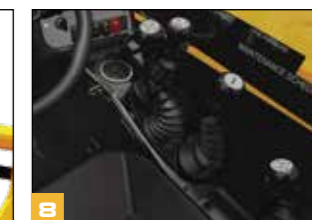
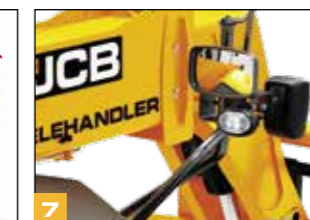
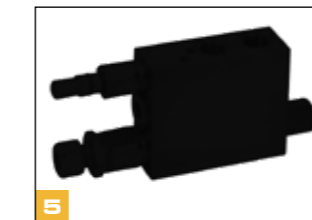

JCB Adaptive Load Control automatically controls hydraulic operation to help maintain the longitudinal stability of your JCB Telehandler.



The operator presence switch on JCB Telehandlers disables drive when an operator leaves the seat; this prevents accidental operation.

VERSATILITY THAT SUCCESS DEMANDS

WIDE RANGE OF ATTACHMENTS: COMPLETING THE SOLUTION.

- 1 For added versatility, all-new JCB Telehandler are fitted as standard with a single boom auxiliary feature that can power a wide range of attachments.
- 2 JCB Q-Fit system makes attachment changeover quick and easy.
- 3 Multiple control patterns are available, for different applications.
- 4 Choose from a wide array of attachments for your different needs.

WIDE RANGE OF ATTACHMENTS FOR ANY APPLICATION



Industrial fork (Standard)



Width of carriage: 1.3 m
Application: Handle palletised loads at construction sites and industries

Short jib crane



Capacity: 3 Ton
Width: 1.2 m
Application: Handling loads at sites.

Truck unloading bucket



Capacity: 0.9 cu.m
Width: 1.8 m
Application: Ceramic, Husk, Ash, Sand Handling

Coal bucket

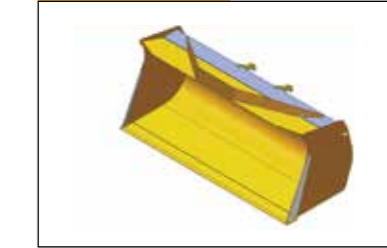

Capacity: 2 cu.m
Width: 2.3 m
Application: Low-density material handling with more strengthening

Unloading rake



Length: 17 ft
Width: 1.5 m
Application: Unloading material from the trucks

Man platform



Capacity: 455 kg
Width: 2.5 m
Application: Maintenance or work at height

6 in 1 Shovel 1800 & 2260mm

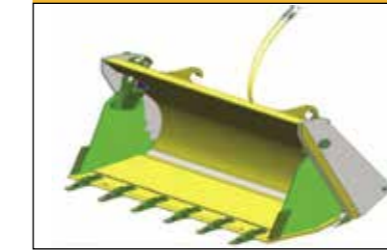

Capacity: 0.81 cu.m / 1.03 cu.m
Width: 1.8 m / 2.26 m
Application: Hopper feeding, Road construction, landscaping SWM

Concrete skip



Capacity: 500 Ltr.
Fork mounted, Hydraulically operated discharge gate
Application: pour concrete mixture in to narrow shuttering or columns

Grain bucket*



Capacity: 2 cu.m
Width: 2.3 m
Application: Low-density material handling

Cotton bucket



Capacity: 2.6 cu.m
Width: 2.43 m
Application: Cotton

Bucket with grab*



Capacity: 1.2-1.3 cu.m / 1.6-1.7 cu.m
Width: 1.8 metre / 2.3 m
Application: General material handling

Round bale clamp*



Capacity: 1100 kgs
Width: 1.6 m
Application: To handle round bales

Power grab



Capacity: 1.6 cu.m
Width: 2.3 m
Application: General material handling / sugarcane handling

Drum handler



Application: Drum handling

Narrow industrial fork*



Width of carriage: 1 metre
Application: Handle palletised loads in confined areas and narrow spaces
Options: Narrow fork with roller and side shift fork are also available.

*Not with Q-FIT.

CONTROL & PRODUCTIVITY THAT'S VERSATILE

INTRODUCING THE NEXT GENERATION



LiveLink is an advanced telematics technology which helps you monitor and manage your machine fleet remotely from anywhere in the world via web or your smartphone.

Power of LiveLink: With LiveLink you can reduce fuel costs, optimise machine, operator performance, proactively manage service and maintenance to maximise uptime. Stay connected to your machines via remote monitoring, experience new levels of control and efficiency with LiveLink.

SERVICE

- Service reminder
- Machine data backup
- Critical machine health alerts
- All diagnostics messages

SECURITY

- GPS tracking
- Towaway alerts
- Operating hours
- Geofencing

OPERATION

- Fuel level information
- Machine utilisation reports
- Engine status
- Time fencing
- Battery charge
- Engine ON/OFF time
- Working Idle time
- Total machine hours
- Total number of engine starts
- Starting engine run hours
- Finish engine run hours

HEALTH ALERTS

- Low engine oil pressure
- High coolant temperature
- Air filter blocked
- Low fuel level
- Transmission oil temperature

FUELTRONICS

- Fuel used in working
- Total fuel used at idle
- Total fuel used
- Average fuel consumption
- Fuel level
- Excess drop in fuel level

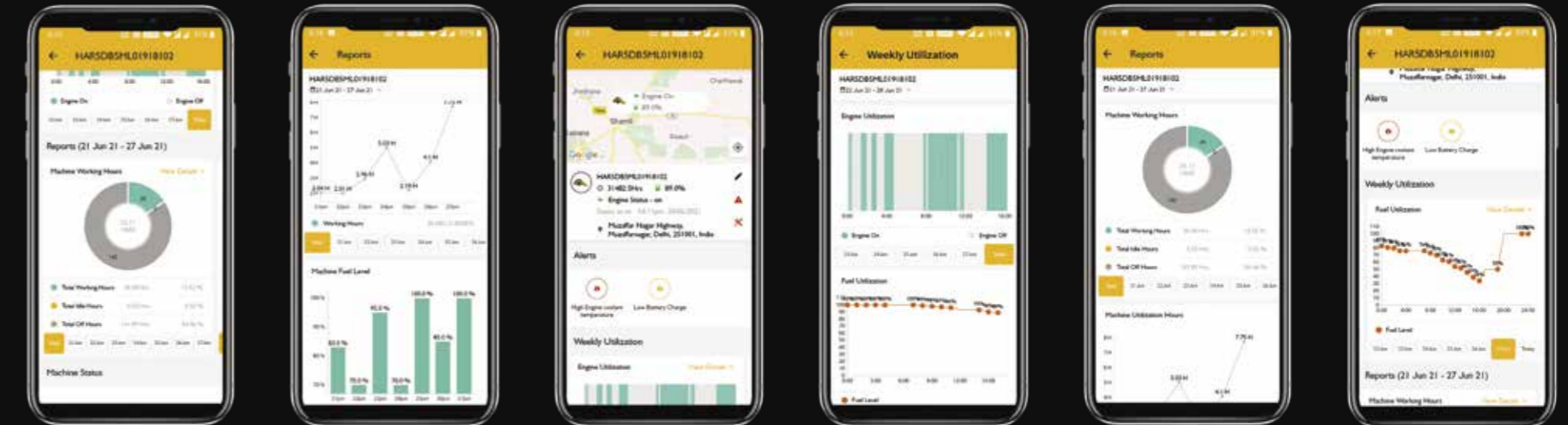

SUCCESS THAT IS ACCESSIBLE & SERVICEABLE

NATURALLY, YOU WANT YOUR JCB TELEHANDLER TO SPEND AS MUCH TIME AS POSSIBLE AT WORK, NOT BEING WORKED ON. WHICH IS WHY JCB TELEHANDLERS HAVE LONG SERVICE INTERVALS; AND, WHEN MAINTENANCE DOES NEED TO BE CARRIED OUT, YOU'LL FIND OUR MACHINES ARE EASY AND QUICK TO SERVICE.

- 1 All daily checks, greasing and serviceable components can be accessed at ground level.
- 2 Battery is easily accessible via a lockable cover that is opened with the ignition key.
- 3 The diesel tank is easy to reach and can be filled from ground level.
- 4 Dry lubricant system - Telehandler's wear pads are extremely durable, with service intervals of 500 hrs.
- 5 The filters on a Telehandler (engine oil, hydraulic oil and fuel) are centrally located for fast, better SAE serviceability ratings.
- 6 Tilttable cooling pack for easy clean in highly dusty condition.
- 7 Reversible fan to ensure maximum operation hours in extremely dusty & choking applications.
- 8 Exhaust scavenging enhances air cleaner life.
- 9 Service interval enhanced to 500 hours.
- 10 Split-type engine pod for better access in engine.



2



3



4



5





NEW

JCB 540-70
Hi Viz

NEW

JCB 540-70
Hi Viz

4 TONNE JCB TELEHANDLER

1 The all-new feature loaded JCB 540-70 is tough, reliable and safer than the rest. Equipped with an enhanced loading capacity of 4 tonne, a maximum lift height of 7.02 m, and an independent braking system, JCB Telehandler with low turning radius is easy to manoeuvre through tight and narrow places. Add to this, the 360° Hi-Viz AC cabin provides maximum comfort & safety to the operator.

2 The Q-fit mechanism aids quick and easy changing of multiple attachments with added stability whereas the new fuel-efficient CEV Stage IV JCB ecoMAX engine lives up to its reputation of being the ultimate engine of productivity.

3 The all-new 4 tonne JCB Telehandler 540-70 is designed to take your businesses like Construction, Crushers and Ready-Mix Concrete to a whole new level.



**4 Tonne
Load Capacity**



**7M
Max. Lift Height**



**1.4 cu.m
Shovel**

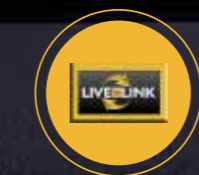

**Advanced
LiveLink**



**AC
Cabin**



Hi-Viz Cabin

VERSATILITY THAT AGRICULTURE PROCESS DEMANDS

THE NEW TELEHANDLER- AGRIHANDLER IS DESIGNED TO WORK IN AGRI BASED INDUSTRY FOR DUSTY AND FLAMMABLE RAW MATERIAL HANDLING. THIS VARIANT IS EMPOWERED WITH EXTRA FEATURES ON STANDARD 530-70 & 530-110.

- 1 Reversible fan:** Reverse cooling fan direction in an interval of 20 minutes, prevent radiator choking even in dusty environment.
- 2 Battery isolator:** Add-on safety feature which can be used in case of short circuit.
- 3 Grain bucket :** Grain bucket with 2 cu.m capacity increases the productivity.
- 4 Fire extinguisher:** Fire protection devise to extinguish or control small fires, often in emergency situations.
- 5 Boom wiper seal:** Prevents dust, agri material from entering the boom.
- 6 Belly plate:** Prevents dust, agri material from entering the lower body.
- 7 Roof aircon:** To maintain consistency of A/C.
- 8 Exhaust cover:** Insulated cover on the exhaust pipe prevents direct contact of Agri products with hot exhaust pipe.



2



3



4



5

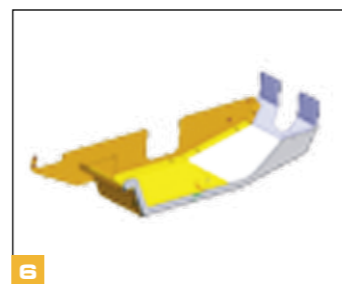

6

VERSATILITY THAT WASTE MANAGEMENT DEMANDS

THE NEW TELEHANDLER WASTE MASTER IS DESIGNED TO WORK IN WASTE RECYCLING INDUSTRY TO RESOLVE STRUCTURAL DAMAGE AND TYRE PUNCTURE ISSUES. THIS VARIANT IS EMPOWERED WITH EXTRA FEATURES ON STANDARD 530-70 AND 530-110.

- 1 Solid tyre:** This offers absolute solution for puncture problems, ensuring maximum machine uptime and lower maintenance cost.
- 2 Heavy-duty axle:** Front axle is specially designed for high load bearing capacity for high machine reliability.
- 3 Front glass & roof protection:** Protect windshield glasses from falling material.
- 4 Fully guarded machine:** Exposed machine parts are guarded e.g Front and rear work lights.
- 5 Front fenders:** To prevent mud & debris to be spill over.
- 6 Boom wiper and guard:** Prevents dust, debris from entering inside the boom and guard to protect Boom wipers.

WASTEMASTER



1



3



5

VERSATILE & PROMPT SERVICE

4000+ CEV STAGE IV
SERVICE ENGINEERS



EXTENSIVE CUSTOMER SUPPORT NETWORK

With 700+ outlets, JCB has widely spread and prompt support system in the construction industry.

One Shop Solution-JCB manufactures all major parts of its machine which are readily available at its dealerships & outlets ensuring rapid customer service support.

4000+ service engineers are trained & certified for CEV Stage IV machines, thereby, quickly resolving any customer concern.

60+
Dealers

700+
Outlets

3000+
Mobile service engineers

18 Operator training centres

5
Parts warehouses

24x7
Support
12 Languages

250+
Mobiles vans

CARE YOU DESERVE

GIVE YOUR MACHINE EXTENDED WARRANTY AND CARE.

- JCB Careplus is an extended warranty programme that comes into effect after the machine's standard warranty expires.
- JCB Careplus can be purchased within the 1st year from the sale of the machine.
- The programme offers you peace of mind and saves your maintenance cost even after your machine's standard warranty expires.



Extended
Warranty
Programme



BENEFITS OF JCB CAREPLUS



No limits on number of claims



Preventive maintenance service*



Nationwide coverage**



JCB skilled manpower support



Maximum productivity



Maximum uptime



Maximum performance



Breakdown cost protection



Better resale value

*Varies on JCB Careplus package selected.
**All services completed in line with the JCB recommended service interval schedule.

JCB LOYALTY PROGRAMME



We believe that customer loyalty is paramount to any brand's success. Our loyalty programme is a reflection of our brand promise and our constant endeavour to offer you more than your expectations.

Instant membership card | Welcome kit
Reward points | Extended benefits
Special programme features

Blue Card



On purchase of a new machine or parts worth ₹1,000

Silver Card



Blue members making a purchase of ₹25,000 in the quarter

Gold Card



Silver members making a purchase of ₹50,000 in the quarter

SMART & DIGITAL SUPPORT

Assured parts supply

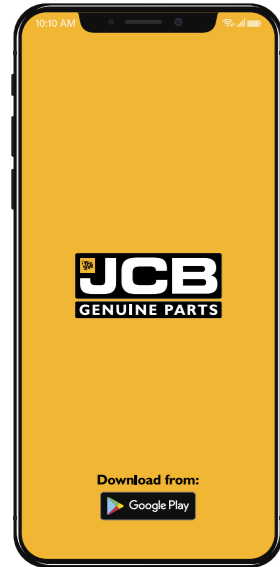

JCB in India have built a robust logistics and supply management chain across the country that facilitates the provision of parts for all machines in the shortest possible time. Customers can now get JCB genuine parts easily and conveniently through its mobile app.

Download from:



Scan the QR Code to connect to JCB Support Facebook Page



Smart Serve



Our service engineers are equipped with Smart Serve technology which enables JCB to send the nearest engineer to the machine, ensuring maximum uptime.

Upgraded connect



Be assured of your JCB machine's service, operation and security parameters with the advanced telematics system - LiveLink and now with the all-new LiveLink mobile app, monitor your machine anytime, anywhere with just a touch.

Download from:



EXTENSIVE PARTS SUPPORT



Our wide range of JCB attachments complete your machine's performance with maximum efficiency and productivity and thus, reduce downtime and increase more savings.

- Value for money
- Perform in synergy with multiple products
- Maximise your machine's performance
- Demonstrate exemplary durability & reliability



Being compatible with JCB machines, the range of JCB lubricants assures better life for all your JCB genuine parts.

- JCB lubricants meet JCB specifications
- JCB lubricants are specially formulated as per JCB specifications
- High-quality base oils blended with very high-quality additive packages
- Peak performance in hazardous condition due to the following reasons:
 - Maintains viscosity at higher temperature and pressure
 - Load carrying capacity
 - Oxidation stability
 - Dispersant
- Complete equipment protection



JCB genuine parts offer a comprehensive machine protection solution. Designed to work in conjunction with JCB fluids in the JCB engines in synergy with other component systems, ensuring:

- Optimum flow and system efficiency
- Maximised engine performance
- Reduced running costs
- Compliance with emission norms
- Protection from system contamination



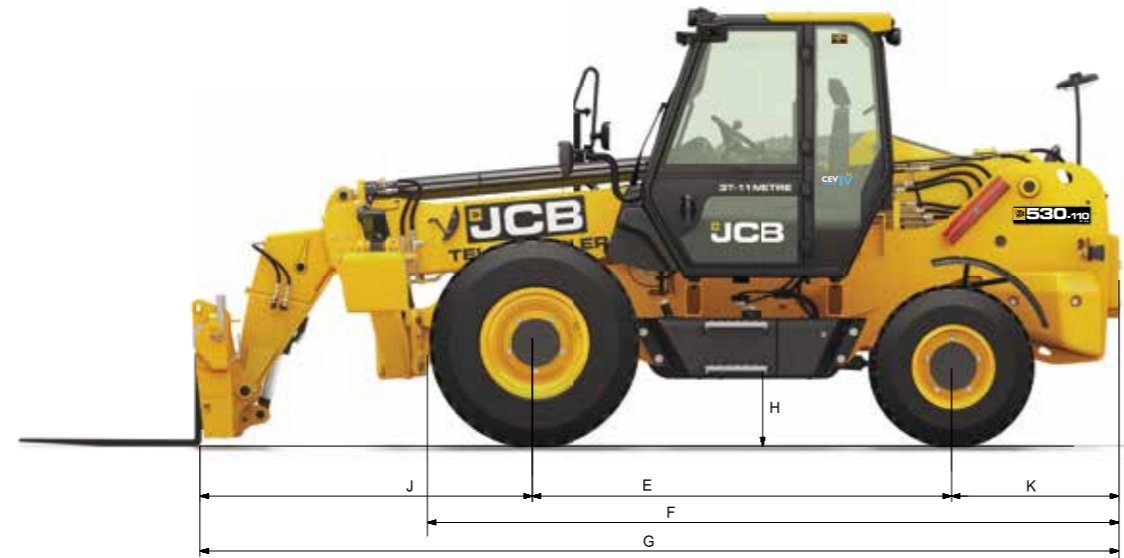

STATIC DIMENSIONS- Dimension - m

Parameters	530-70	NEW 540-70	530-110
A Overall height	2.64	2.64	2.64
B Overall width (over tyres)	2.4	2.4	2.4
C Inside width of cab	0.79	0.79	0.79
D Front track width	1.99	1.99	1.99
E Wheelbase	2.54	2.54	2.54
F Overall length to front tyres	4.13	4.13	4.13
G Overall length to front carriage	4.92	4.92	5.43
H Ground clearance	0.39	0.39	0.39
J Front-wheel centre to carriage	1.42	1.42	1.93
K Rear-wheel centre to rear face	0.95	0.95	0.95
Operating weight	7510 (with Fork)	8615 (with Fork)	9490 (with Fork)
Outside turn radius (over tyres)	4.85	4.85	4.85
	Bucket rollback angle (at ground) 41 deg.	Bucket rollback angle (at ground) 41 deg.	Bucket Rollback Angle (at ground) 38 deg.
	Bucket dump angle (at full height) 26 deg.	Bucket dump angle (at full height) 26 deg.	Bucket dump angle (at full height) 12 deg.
			Overall width with stabilisers fully deployed 2.65 m

LIFT PERFORMANCE

JCB TELEHANDLER 530-70 | SPECIFICATION **JCB TELEHANDLER 540-70 | SPECIFICATION**

Operating weight : 7154 kg Max. payload : 3 tonnes
Max. lift height : 7 metres

Operating weight : 8100 kg Max. payload : 4 tonnes
Max. lift height : 7.02 metres

JCB TELEHANDLER 530-110 | SPECIFICATION

Operating weight : 9060 kg Max. payload : 3 tonnes
Max. lift height : 11 metres

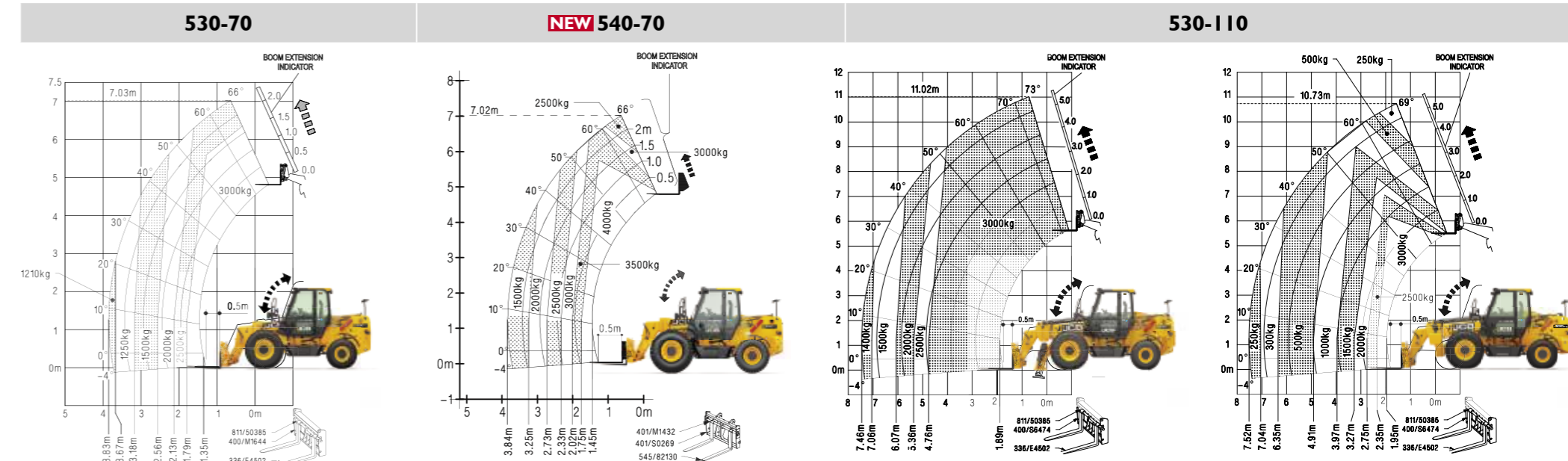

		530-70	NEW 540-70	530-110
				With stabilisers extended
Maximum lift capacity	kg	3000	4000	3000
Lift capacity to full height	kg	2500	2500	250
Lift capacity at full reach	kg	1210	1500	250
Lift height	m	7.0	7.02	11.0
Reach at maximum lift height	m	1.0	0.63	0.9
Maximum forward reach	m	3.83	3.84	7.46
Reach with 1 tonne load	m	3.83	3.84	7.46
Placing Height	m	6.3	6.5	10.5
				With stabilisers retracted
				10.73
				250
				1.5
				7.52
				4.91
				10.25

* All dimensions, weights and timings are variable within 1.5%. JCB reserves the right to change specifications without prior notice.

ENGINE

JCB ECOMAX 444 TCIC CEV4 with EGR Cooler diesel engine
Displacement: 4.4 L

Gross power: 55 kW (74 hp) @ 2200* rpm

Max torque: 400 Nm (40.78 kgm) @ 1200 rpm

*Operating RPM @ 2000

TRANSMISSION

JCB 4WD synchro shuttle transmission. 4-speed fully synchromesh gearbox with integral torque converter and electrically operated forward - reverse shuttle.

- Easy to use, column-mounted electric switch allows operator to change machine direction while in motion without taking his hands off the steering wheel. This leads to safe and efficient operation and cycle times.
- The pedal layout and conventional 4-pattern gear lever with transmission switch adds to the overall ease of operation.
- Torque converter stall ratio 2.52:1.
- 4WD can be selected at any time on the move with a simple electric switch.
- Additional transmission dump provided on loader lever, to help disengaging transmission in need of higher hydraulic power demand.

AXLES

Front axle:

JCB drive axle rigidly mounted incorporates JCB max-track torque proportioning differential, driven by propeller shaft from gearbox.

Rear axle:

4WD steer drive axle centrally pivoted with oscillation angle of 16°, driven by propeller shaft from gearbox.

BRAKES

Service: Hydraulically actuated, dual-line, self-adjusting, compensated oil-immersed, multi-disc type on the front axle, operated through independent pedals, linked together for normal use. Two independently operating foot pedals enable machine to manoeuvre in tight spaces.

Parking: Hand-operated cable-actuated disc brake mounted on front axle input disc and additionally transmission dump.

* All dimensions, weights and timings are variable within 1.5%, JCB reserves the right to change specifications without prior notice.

STEERING

- Rear-wheel hydrostatic power steering with manual capability in the event of engine or hydraulic power failure.
- Inner angle 38° & Outer angle 30°

ELECTRICALS

- 130 Ampere-hour, 12 Volts battery system with alternator and full road lighting.
- Dust and waterproof IP69 electrical connectors.

TYRES

Front : 13.00 x 24 -16PR

Rear : 12.5 x 18 -12PR Industrial traction pattern tyres

Tyres Option : HD Tyres / Extra HD Tyres / Solid Tyres / Agri Tyres

SPEED

Maximum road speed : 30 km/hr

SERVICE CAPACITIES

Fuel tank	110 L
Hydraulic tank	120 L
Engine coolant	27 L
Engine oil	14.2 L
Transmission	18 L
Front axle	21 L
Rear axle	11 L

OPTIONS & ACCESSORIES

- Windscreen & Roof Guard
- Rear Grill Guard
- Boom & Rear Working Lights
- Hydraulic Cut-off
- Dome Mirror
- Fire Extinguisher
- Reversible Fan
- Tool Kit
- Grease Bucket
- Rear View Camera

CABIN

- Conform to ROPS ISO 3471 & FOPS ISO 3449 tinted & laminated cab glass provides excellent all-round visibility & sun protection.
- A fully adjustable seat with seat belt combined with ergonomically positioned controls and soft-touch steering wheel maximise operator output.
- Large convex rearview mirror, interior light, front screen wiper, front and rear horn, hazard warning system and toolbox.
- Instrumentation panel includes engine speed, engine hours, fuel level, water temperature and 12V socket for mobile charger.
- Longitudinal load moment Indicator (LLMI) & inclinometer to provide warnings on machine stability.
- 2 speed full ducted AC unit in cabin.

HYDRAULICS

	530-70	NEW 540-70	530-110
Pump	2 Section Gear		
Pump capacity	108 lpm		
Main relief valve	(245 bar) 24500000 Pa		
Hydraulic cycle times (in sec) with Bucket			
Boom up	9.1	9.18	9.5
Boom down	7.1	6.68	9.3
Crowd	3.3	3.98	2.6
Tilt	2.7	2.94	2
Extend	5.6	6.16	14.2
Retract	3.9	3.36	17.2

- Filtration through suction strainer and return line 'JCB filtromatic filter'.
- During lifting, the circuit automatically adjusts the pump flow to provide more power for lifting operation.

LIVELINK

Advanced telematics system that enables you to monitor and manage your machines remotely by providing information on :

Service : Routine maintenance information and alerts

Operation : Health alerts and usage data

Security : Machine location & movement data

CUSTOMER SUCCESS STORIES



MAHENDRA AGARWAL
CEO - GR Infraprojects Ltd.

BUILDING AND CONSTRUCTION INDUSTRY

The Telehandler has easy handling and smooth manoeuvrability for great operator comfort.

This machine has great versatility and diversity and can work in many ways and situations. This machine gets things done faster than other machines.



NAVIN BHAI D PATEL
Shreyasia Constructions

CERAMICS INDUSTRY

Our first JCB machine till date has performed 12,500 hours with flawless performance.

Initially, we use to work with labourers and the output was 4000 tonne per month but after we got our first JCB telehandler machine the output scaled to 12000 tonnes per month. We have been associated with JCB for the past three years.



GOPI KAKKAR
Supercon Associates Partner

RMC INDUSTRY

In terms of fuel efficiency we are now saving around 15 to 20% more fuel with this machine.

Productivity wise our earlier machine had a smaller bucket which could carry only 1 tonne while the telehandler can carry 2.5 tonnes. Stockpiling with this machine has a higher reach that helps to store materials in a larger quantity.

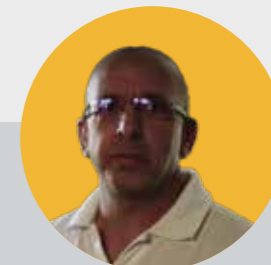

Dr. SAAR
CEO, Godrej Maxximilk

AGRICULTURE AND DAIRY INDUSTRY

We are very happy with the multi-purpose JCB Telehandler.

Our JCB Telehandler is used as a big bucket to mix cattles' feed, unloading and loading dense materials, and cleaning our stands which are blended with animal dung. The baler clamp helps us shift the silage and protect the nylon packaging.



ONE COMPANY, OVER 300 MACHINES.

Dealer's stamp:

JCB INDIA LIMITED 23/7 Mathura Road, Ballabgarh - 121 004 Haryana, India. Fax: 91 129 2309050

For more information SMS **"JCB"** to **56767** or call our toll free no. **1800-1037-386**

Website: www.jcb.com

Follow us: [f](#) [t](#) [v](#) [i](#) [in](#) /JCBIndiaLtd

©2009 JCB Sales. All rights reserved. No part of this publication may be reproduced, stored in a retrieval system, or transmitted in any form or by any other means, electronic, mechanical, photocopying or otherwise, without prior permission from JCB Sales. All references in this publication to operating weights, sizes, capacities and other performance measurements are provided for guidance only and may vary dependant upon the exact specification of machine. They should not therefore be relied upon in relation to suitability for a particular application. Guidance and advice should always be sought from your JCB Dealer. JCB reserves the right to change specifications without notice. Illustrations and specifications shown may include optional equipment and accessories. The JCB logo is a registered trademark of J C Bamford Excavators Ltd.

The pictures used and facts given are graphic representations and approximate values. The actual color and numbers may vary.

